

Tiandy



TC-C32WS Spec: I5/E/Y/C/H/2.8mm(4mm)

2MP Fixed Starlight IR Bullet Camera

Pro Series



KEY FEATURES

- Metal+Plastic
- Up to 1920x1080@30fps
- S+265/H.265/H.264
- Min. illumination Color: 0.002Lux@F1.6
- Smart IR, IR Range: 50m
- Support tripwire and perimeter
- Built-in Mic, SD Card Slot, Reset Button
- Audio I/O 1/1, Alarm I/O 1/1
- Operating Conditions -35°C~65°C, 0~95% RH
- POE, IP67



Tiandy Technologies Co.,Ltd.

Email: sales@tiandy.com Tel: +86-22-58596178
Website: en.tiandy.com Fax: +86-22-58596048



SPECIFICATIONS

Camera	
Image Sensor	1/2.8" CMOS
Signal System	PAL/NTSC
Min. Illumination	Color:0.002Lux@(F1.6,AGC ON),B/W:0Lux with IR
Shutter Time	1s to 1/100,000s
Day & Night	Dual IR Cut Filter with Auto Switch
WDR	120dB
Angle Adjustment	Bracket,pan:0° to 360°,tilt:0° to 75°,rotate:0° to 360°
Lens	
Lens Type	Fixed
Focus	2.8mm/4mm
Lens Mount	M12
Aperture	F1.6,Fixed
FOV	Horizontal field of view:99.7°(2.8mm)/88.3°(4mm); Vertical field of view:55.1°(2.8mm)/46.8°(4mm)
Illuminator	
IR LEDs	2
IR Range	Up to 50 m
Wavelength	850nm
White LEDs/Warmlights	N/A
Compression Standard	
Video Compression	S+265/H.265/H.264
Video Bit Rate	32Kbps~6Mbps
Audio Compression	G.711A/G.711U/ADPCM_D_D
Audio Bit Rate	8K,32K,48Kbps
Image	
Max. Resolution	1920x1080
Main Stream	PAL:25fps(1920x1080,1280x720,704x576,640x480) NTSC:30fps(1920x1080,1280x720,704x480,640x480)
Sub Stream	PAL:25fps(704x576,704x288,640x360,352x288) NTSC:30fps(704x480,704x240,640x360,352x240)
Third Stream	N/A
Image Setting	Saturation,brightness,contrast,sharpness,adjustable by client software or web browser
Image Enhancement	BLC/3D DNR/HLC
ROI	Support 8 fixed regions of coding
OSD	16x16,32x32,48x48,adaptable size,Letters Such as Week,Date,Time,Total 1 Regions
Picture Overlay	N/A
Privacy Mask	Yes,4 regions
Smart Defog	Yes
Feature	
Alarm Trigger	Motion Detection,Mask Alarm,IP Address Conflict
Video Analytics	Tripwire,Perimeter
Early Warning(EW)	N/A
Network	
ANR	Yes(Only Support Tiandy ANR NVR)
Protocols	HTTP,TCP/IP,UDP,UPnP,ICMP,DHCP,DNS,DDNS,Easy DDNS,NTP,IPv4,RTSP,RTMP
System Compatibility	ONVIF(PROFILE S/T/G),SDK,CGI,Milestone,P2P(Mutually exclusive with Profile G)
Remote Connection	2
Client	Easy7,EasyLive Plus
Web Version	Web6

Tiandy

Interface	
Communication Interface	1 RJ45 10M/ 100M self adaptive Ethernet port
Audio I/O	1/1,Mic in
Alarm I/O	1/1
Speaker	N/A
Reset Button	Yes
On-board storage	Built-in MicroSD card slot,up to 512 GB
General	
Web Client Language	17 languages English,Russian,Spanish,Korean,Italian,Turkish,Simple Chinese,Traditional Chinese,Thai,French,Polish,Dutch,Hebraism,Arabic,Vietnamese,German,Ukrainian
Operating Conditions	-35°C~60°C ,0~95% RH
Power Supply	DC 12V±25%,PoE(802.3af)
Power Consumption	MAX:6W(12V) MAX:8W(POE)
Protection	IP67
Heater	N/A
Dimensions	160.8x68x74.5mm(6.33x2.68x2.93 inch)
GrossWeight	0.47Kg(1.03lb)
NetWeight	0.31Kg(0.68lb)

* Listed resolutions are only selectable options. It does not mean that all streams can work at their maximum resolution at the same time.

AVAILABLE MODEL

TC-C32WS SPEC: I5/E/Y/C/H/2.8MM V4.0

TC-C32WS SPEC: I5/E/Y/C/H/4MM V4.0

DIMENSIONS

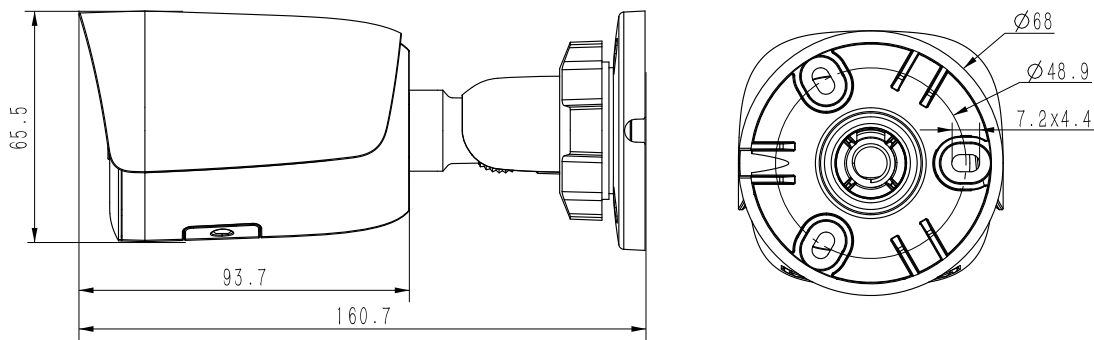

ACCESSORIES

A35
CORNER MOUNT



TC-P54BM SPEC: V5
JUNCTION BOX



A36
POLE MOUNT

DISTRIBUTED BY



Tiandy Technologies Co.,Ltd.

Email: sales@tiandy.com
Website: en.tiandy.com

Tel: +86-22-58596178
Fax: +86-22-58596048